

LSS-0457 Single-Longitudinal-Mode DPSS Laser System



Series Specifications:

| | |
|--------------------|--------|
| Nominal Wavelength | 457 nm |
| Output Type | CW |
| Laser Source Type | DPSS |

Overview:

The LSS-0457 Series of Single-Frequency, Single Longitudinal Mode Diode-Pumped Solid-State (DPSS) lasers are ideal for applications requiring extremely long temporal coherence and a narrow spectral linewidth. This series of 457 nm SLM lasers are available with up to 100 mW output power, and maintain a high level of long-term output power stability and long operating lifetime.

These lasers are commonly used for various scientific and industrial purposes such as holography, interferometry, spectroscopy, biological experiments, etc. The driver is available as a complete FDA-compliant system or as an O.E.M. component with significantly reduced dimensions.

Laserglow products are currently being used by some of the World's top universities and other prominent research facilities.

Key Features:

- Coherence length >50 m
- Spectral linewidth <0.000001 nm
- Air cooled - no need for water cooling or external chiller
- Lightweight, compact design
- Efficient DPSS technology runs on standard AC power (85 - 264 V, 47 - 63 Hz)
- >10,000 hours continuous maintenance-free operating life
- FDA/CDRH Compliant Class IIIa/IIIb
- 48-hour replacement coverage available for an additional fee on specific models

Package Includes:

- Laser Head
- Driver/Power Supply
- Power Cable
- BNC Connector (LabSpec models only)
- Keys, Safety Interlock
- Hard-shell Carrying Case

Specifications:

This spec sheet has been generated specifically for part number S45-O, per your request, and data for the entire series is also displayed for your reference. The specs which are specific to S45-O have been highlighted below in **red + bold**.

| | | | |
|--|---|-----------------------------------|------------------------------|
| Output Power (mW) | <5, >30, >50, >100, >150, >200, >300, >400 | >50, >100, >150, >200, >300, >400 | >500, >1000, >1500, >2000 |
| Output Power Stability (%RMS/4h) | <1, <2, <3, <5 | <1, <3, <5 | <1, <3, <5 |
| Central Wavelength (nm) | 456.63 | 457 | |
| Wavelength Tolerance (+/- nm) | 1 | 1 | |
| Divergence (mrad, full angle) | <1.2 | <1.2 | <1.5 |
| Beam Dimensions (mm, 1/e ²) | 2 | 2 | 2 |
| Warm-up Time (minutes) | 10 | 10 | |
| Spectral Linewidth (nm) | <4.0E-6 | <4.0E-6 | |
| M ² | <1.2 | <1.2 | <1.2 |
| Polarization Ratio | >100 | >100 | |
| Coherence Length (m) | >50 | >50 | |
| Beam Pointing Stability (mrad) | <0.05 | <0.05 | |
| Operating Temperature Range (°C) | 10 to 35 | 15 to 35 | |
| Max. Power Input Duty Cycle | 100% | 100% | 100% |
| Standard Warranty (months) | 12 | 12 | 12 |
| MTTF (operational hours) | 10000 | 10000 | 10000 |
| Weight of Product or Laser Head (kg) | 2 | 3.6 | 5.7 |
| Beam Height from Base Plate (mm) | 27.4 | 84.7 | 56 |
| Dimensions of Product or Laser Head (mm) | 197 (l) x 70 (w) x 50 (h) | 197 (l) x 117.5 (w) x 107.3 (h) | 386.5 (l) x 166 (w) x 88 (h) |

CW: All specifications are based on performance at full output power and after the specified warmup period. Output characteristics may change if the laser is run at a different power level.

Q-Switched: Specifications are based on the laser pulsing at the specified design frequency. Output characteristics may change if the laser is run at a different frequency.

Power Supply Options:

These lasers are available with several different power supply options. The model that you have selected is highlighted below, and any other options are shown for easy reference.

| | Power Supply Type: | SO | SW |
|---|--------------------------|------------------------------------|-----------------------------|
|  FDA-Compliant Standard | Input Power | 85v to 264v | 85v to 264v |
| | Power Supply Weight (kg) | 2.3 | 5.1 |
| | Dimensions (mm) | 238 (l) x 146 (w) x 102 (h) | 307 (l) x 168 (w) x 123 (h) |

*Power supply may not be exactly as shown, see dimensional drawings on next 2 pages.

*Dimensions for fiber-integrated (I_) include laser head packaged inside.

Regulatory Classification:

The model you have selected (S45-O) requires the following safety label(s):



Dimensional Drawing - Laser Form Factor: O:

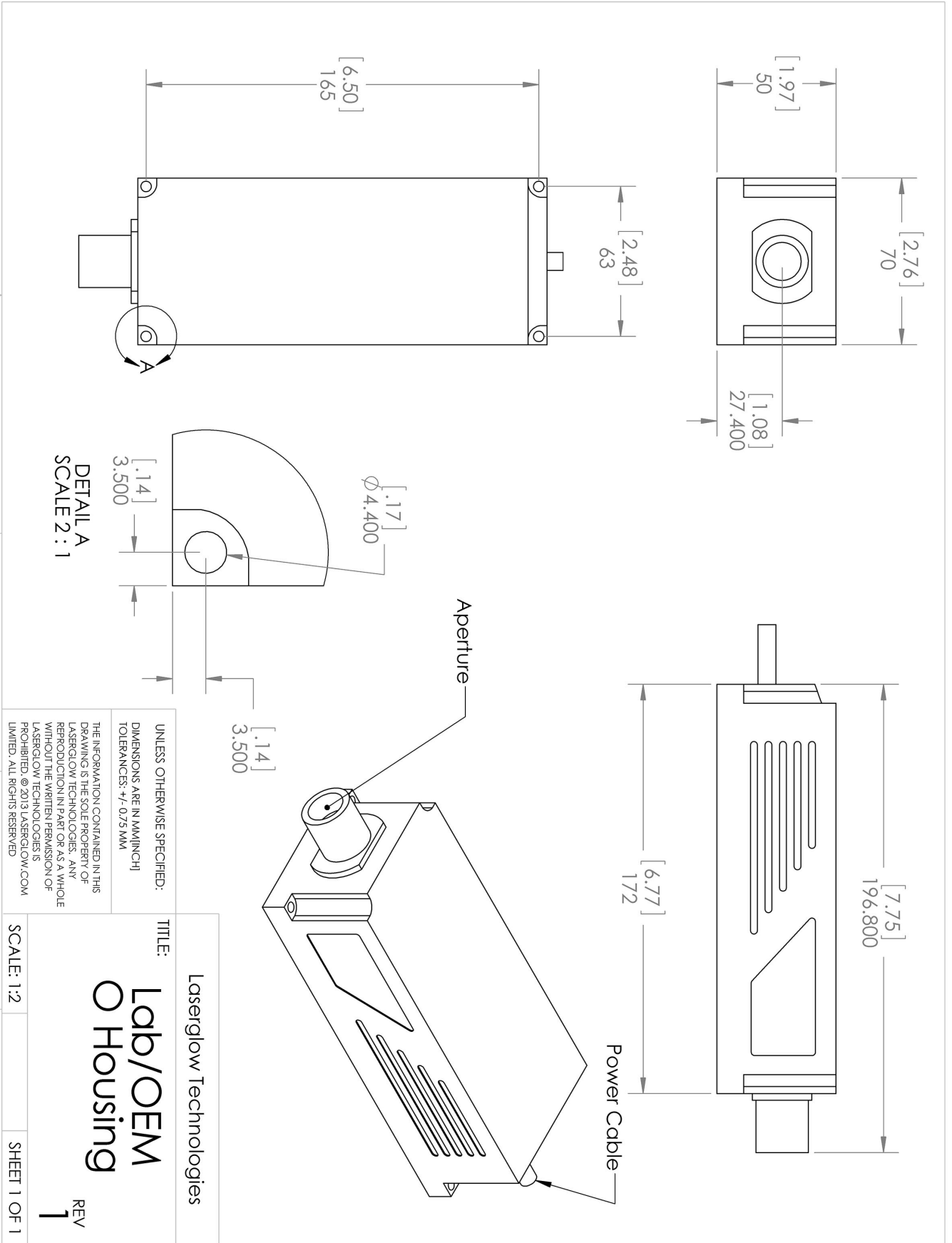

Dimensional Drawing - Power Supply Form Factor: SO:

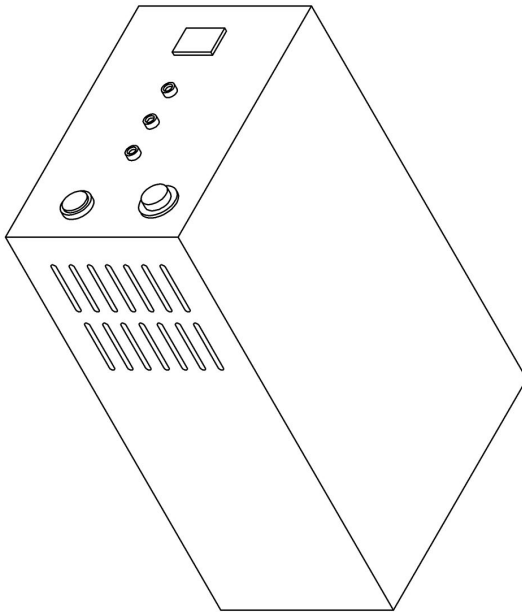
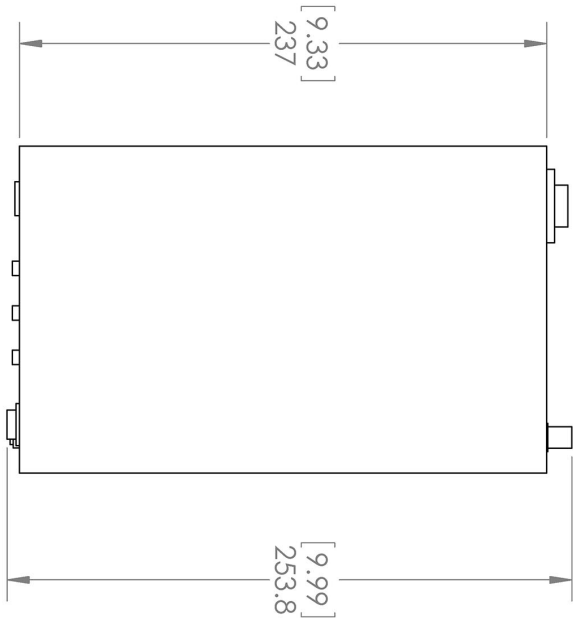
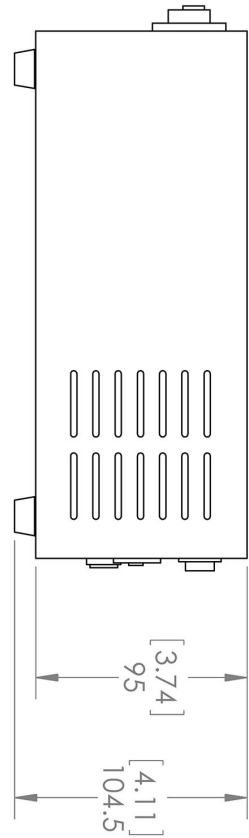
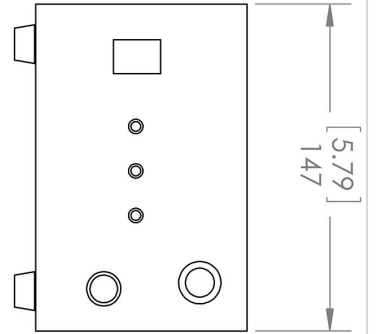







UNLESS OTHERWISE SPECIFIED:
 DIMENSIONS ARE IN MM(INCH)
 TOLERANCES: +/- 0.75 MM

THE INFORMATION CONTAINED IN THIS
 DRAWING IS THE SOLE PROPERTY OF
 LASERGLLOW TECHNOLOGIES. ANY
 REPRODUCTION IN PART OR AS A WHOLE
 WITHOUT THE WRITTEN PERMISSION OF
 LASERGLLOW TECHNOLOGIES IS
 PROHIBITED. © 2012 LASERGLLOW.COM
 LIMITED. ALL RIGHTS RESERVED

| | |
|---|--|
| TITLE: Laserglow Technologies | |
| SCALE: 1:3 | |
| SHEET 1 OF 1 | |
| Power Supply SA/SO/ST/SV REV 1 | |

Accessories:

The most popular accessories for model S45-O are shown below. For additional details regarding these or other accessories please see our website or contact us directly.

| Part Number | Description | |
|--|--|---------------------|
|  AFS2002XX | Armored Fiber With SMA 905 Connectors 200um Core Multimode 2 m length Full Details: www.laserglow.com/AFS | |
|  AFF2002XX | Armored Fiber With FC/PC Connectors 200um Core Multimode 2m length Full Details: www.laserglow.com/AFF | |
|  ACALBHFXX | Carrying Case-103 Holds Lab/OEM H, F and O size Standard/LabSpec laser Full Details: www.laserglow.com/ACA | Included With Laser |
|  ACSVISHXA | SMA-905 Fiber Coupler/Collimator for visible spectrum wavelengths (400 to 700 nm) (installed and aligned) 11mm diameter input lens Full Details: www.laserglow.com/ACS | |
|  ACFVISHXA | FC/PC Fiber Coupler/Collimator for visible spectrum wavelengths (400 to 700 nm) (installed and aligned) 11mm diameter input lens Full Details: www.laserglow.com/ACF | |
|  AGF5327XX | LSG-532-NF-7 Fit-Over Safety Goggles 532nm Output: OD 7+ at 190-532 nm CE Certified Full Details: www.laserglow.com/AGF | |
|  TBK | Complete optics kits with breadboard mounting hardware. External modulators, variable attenuators, free-space fiber launch systems Full Details: www.laserglow.com/TBK | |

FOR MORE INFORMATION PLEASE CONTACT:

LASERGLOW TECHNOLOGIES
99 Ingram Dr. Unit B, North York, ON, Canada M6M2L7
Tel. (416) 729-7976 Fax (716) 322-3510
sales@laserglow.com www.laserglow.com

E&OE: Data included in this sheet may be subject to change without notice.

Please confirm critical specifications with our staff prior to ordering.